

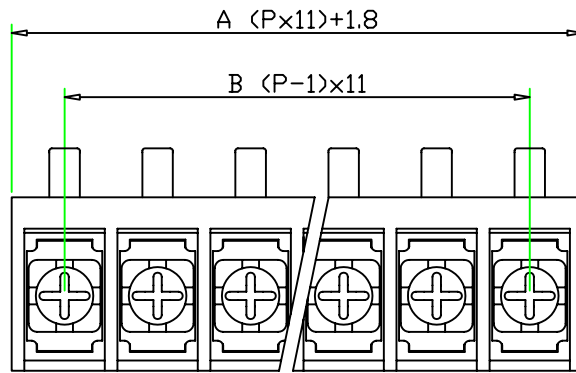

HOWDER

Closed Barrier type terminal block



Part Number:

HD-335-P

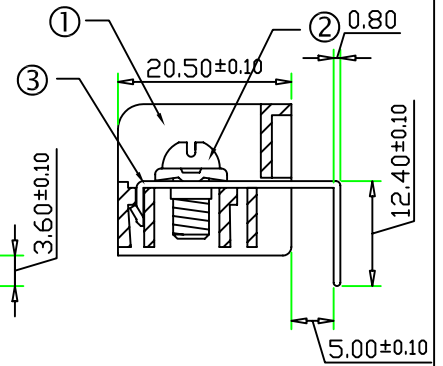
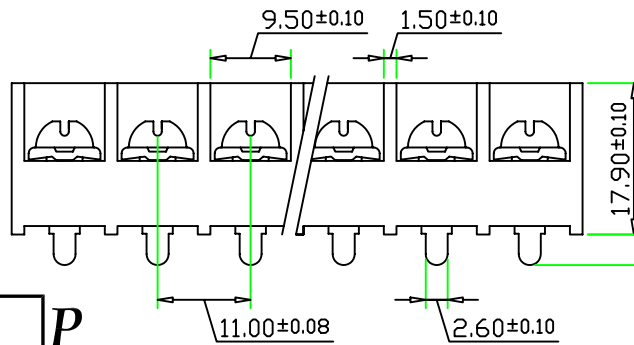

Pole Size 2~32P

SPECIFICATIONS

- ① Housing Material: Polyamide 66(UL94V-0), Black
- ② Screw: M4.0 Nickel Plated Steel
- ③ Terminals: Tin Plated Brass

Screws Torque: 20 In-Lb

Wire Range: 12~22 AWG

Rated: 30 Amperes.AC300V

Operation Temperature: $-55^{\circ}\text{C} \sim +95^{\circ}\text{C}$

Insulation withstands volt: AC2000V min

Insulation resistance: $>1000\text{M}\Omega$ or more at DC500V